



USERS MANUAL

Golf Cart Lithium Battery



RoyPow (USA) Technology Co., Ltd

Address: 107 Halmar Cove #131, Georgetown, TX 78628

Tel: (682) 219 5680

www.roypowtech.com

WARRANTY INFO:

Serial number _____

Purchase date _____

Welcome to RoyPow Products

RoyPow provides safe and renewable golf cart battery. Our golf cart lithium battery packs are designed with integrated golf cart battery system, the batteries are used in replacement for the lead-acid battery, which are available for drop-in replacement in the Club Car and EZ-GO etc.

Please read the user manual carefully before using the product and always take care when using this product. This product is not intended for use by young or infirm persons without supervision.

OVERVIEW

The S5156 and S51105 are part of the golf carts series of Lithium batteries. These batteries are equipped with an integrated cell management system which features:

- Cell balancing
- Battery voltage monitoring
- Battery current monitoring
- Pre-warning when battery is almost empty (communication by means of RS485)
- Battery temperature monitoring (integrated temperature sensor)

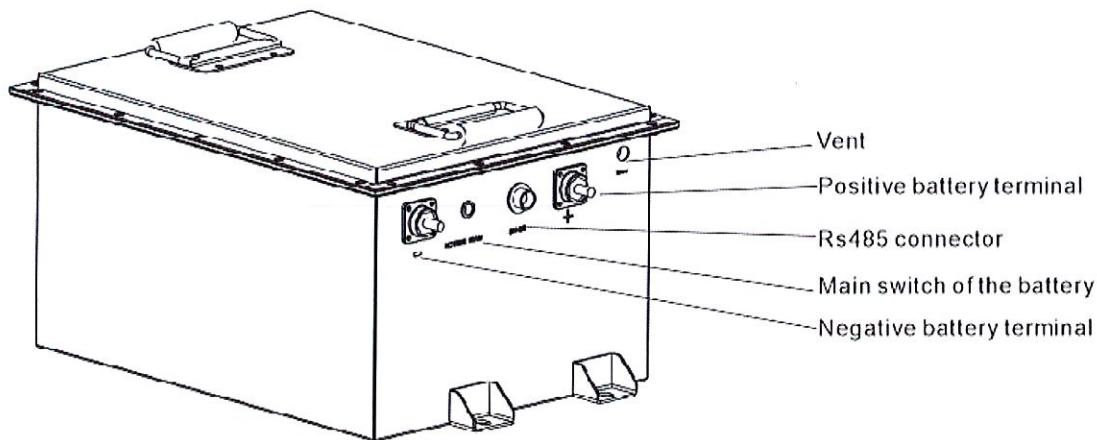

Note: Press and hold the "MAIN SWITCH" button for 5 seconds to turn on/off the battery, green light indicates power on.

DELIVERY CONTENTS

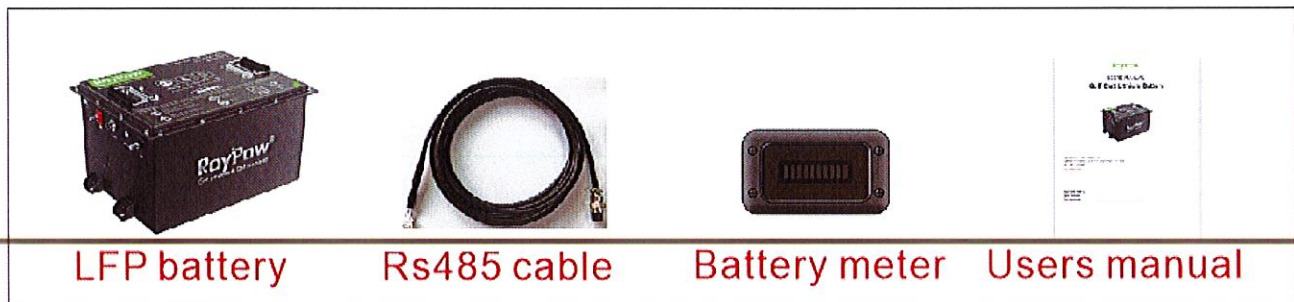

Note: Follow next steps to install the gauge:

- 1 Install the gauge in a suitable position on the golf cart
- 2 Connect one end of the RS485 cable to the RS485 connector on the battery, and then connect the other end to the gauge.

Battery replacement steps for CLUB CAR/E-Z-GO

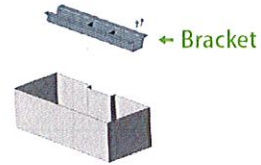
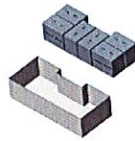
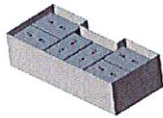

← Bracket

CLUB CAR

01

Open the golf cart compartment, you will see the original lead-acid batteries.

02

Disconnect all the wires safely, and pull the batteries out.

03

Fasten the bracket in the compartment as the base

05

Connect the wires safely, then you are ready to go.

04

Put the pack inside and fasten the pack to the bracket base

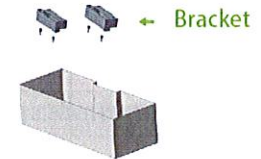
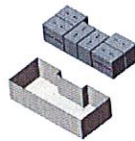
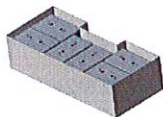
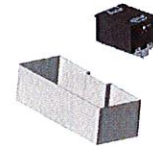

← Bracket

E-Z-GO

01

Open the golf cart compartment, you will see the original lead-acid batteries.

02

Disconnect all the wires safely, and pull the batteries out.

03

Fasten the bracket in the trunk as the base

05

Connect the wires safely, then you are ready to go.

04

Put the pack inside and fasten the pack to the bracket base

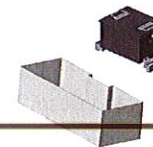
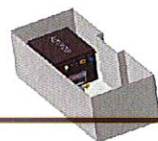

Note: only authorized personnel is allowed to operate or make adjustments to the battery.

Specification

Model		S38105	S5156	S51105	S51160
Technical Parameter	Nominal voltage	38V	51V	51V	51V
	Nominal capacity	105Ah	56Ah	105Ah	160Ah
	Stored energy	4kWh	2.8kWh	5.3kWh	8.1kWh
	Life cycles	>3500 times	>3500 times	>3500 times	>3500 times
	Self discharge	Max 3% per month	Max 3% per month	Max 3% per month	Max 3% per month
Standard charge current	Continuous charge	105Ah	56Ah	105Ah	160Ah
Standard discharge current	Continuous discharge	300A	165A	300A	300A
	Maximum discharge	300A	300A	300A	300A
Charging time	Quick charge	1.0 h	1.0 h	1.0 h	1.0 h
	Standard charge	5 h	2.5 h	5h	7.5h
Environment	Charge temperature range	32°F~131°F (0°C ~ 55°C)	32°F~131°F (0°C ~ 55°C)	32°F~131°F (0°C ~ 55°C)	32°F~131°F (0°C ~ 55°C)
	Discharge temperature range	-4°F~131°F (-20°C ~ 55°C)	-4°F~131°F (-20°C ~ 55°C)	-4°F~131°F (-20°C ~ 55°C)	-4°F~131°F (-20°C ~ 55°C)
	Storage temperature range	-4°F~113°F (1 month) (-20°C~45°C)	-4°F~113°F (1 month) (-20°C~45°C)	-4°F~113°F (1 month) (-20°C~45°C)	-4°F~113°F (1 month) (-20°C~45°C)
		32°F~95°F (1 year) (0°C~35°C)	32°F~95°F (1 year) (0°C~35°C)	32°F~95°F (1 year) (0°C~35°C)	32°F~95°F (1 year) (0°C~35°C)
General	Cell combination	1P12S	1P16S	1P16S	1P16S
	Cell combination	LF105 (3.2V 56Ah)	LF56 (3.2V 56Ah)	LF105 (3.2V 105Ah)	LF160 (3.2V 105Ah)
	Casing material	Stainless steel	Stainless steel	Stainless steel	Stainless steel
	Weight	77 lbs (35kg)	73 lbs (33.1 kg)	95.2 lbs (43.2 kg)	159 lbs (72 kg)
	Dimension (L*W*H)	36.3*33.8*23.2cm	46*32.6*24.3cm	46*32.6*24.3cm	80*31.8*21.2cm
	IP rate	IP56	IP56	IP56	IP56

Warnings:

- Do not disassemble, resemble, or repair the battery. Incorrect reassembly may cause combustion or electric shock.
- If the battery is damaged, contact the place you purchased it.
- Do not short-circuit the battery, use it near heat or water sources, or allow it to become wet.
- Do not insert nails or other objects into the battery, strike it, or weld directly on the battery.
- Do not use a badly damaged battery or operate it with damaged cables or charging adapters.
- Do not operate this product in explosive atmospheres (i.e. flammable liquids, gases, or dust) or set the unit on flammable materials (i.e. carpeting, upholstery, paper, cardboard).
- Do not permit the battery to freeze. Never charge a frozen battery.
- In case of skin or eye contact, rinse immediately with clean water and seek medical attention.
- Do not keep using this product if it is damaged, waterlogged, distorted, or broke.
- This product contains lithium ion batteries. When it is worn out dispose it properly using local laws and regulations.

Handling and Maintenance

Storage:

- For storage over one month, place the battery in a dry and ventilated room that is 32°F~95°F.
- Do not store near corrosive material, fire, and heat sources.
- In order to avoid over discharge, for long-term storage, the power must be turned off and the SOC is kept above 60% to avoid over discharge.the battery must be fully charged and must be charged again every 3 months.

Operation

- **ATTENTION:** Before installing, make sure that all appliances are turned off.
- Turn on/off the battery

Press and hold the "MAIN SWITCH" button for 3 seconds to turn on/off the battery, green light indicates power on.

- Remaining battery capacity

Once the battery is turned on, you can press the "SOC" button to check the remaining battery capacity. The gauge will light up for 3 seconds, there are ten bar in total, and the reference power of each bar is 10%.

- Alarm

The battery may shut down immediately due to over-temperature, over-current, under-voltage, and external short-circuit. When there are only two bars left in the gauge, the gauge will sound an under-voltage alarm, It means the battery need to be charged. When there is only one bar left in the gauge, the gauge will sound an under-voltage alarm again, and LED indicator is blinking, once this happens, stop driving immediately and charge the battery as soon as possible.

Disclaimer: Once the gauge sounds an alarm, stop driving and charge the battery as soon as possible. Continue driving will cause the golf cart to suddenly stop. We are not responsible for any loss caused by the sudden stop of driving in this case.

- Charging

This battery needs to be used with the designated charger we sell, otherwise it may cause insufficient charging or battery damage. We are not responsible for any problems caused by this.

WARRANTY REPAIRS/REPLACEMENTS

Your Battery is warrantied for FIVE years from date of purchase at retail against defective material or workmanship. We make no warranty other than this limited warranty and expressly exclude any implied warranty including any warranty for consequential damages. This limited warranty is not transferable.

Seller warranty this product, if used in accordance with all applicable instructions, to be free from original defects in material and workmanship within the warranty period. If the product has any failure problem within the warranty period, Seller will repair or replace the product at its sole discretion according to the failure situation.

LIMITED WARRANTY

Save proof of purchase, such as a dated receipt. This warranty for the unit is extended to the original purchaser or user, and it may cover defects in materials and workmanship.

For malfunction due to defects in materials or workmanship six months from the purchase date, we will repair or replace the unit at our discretion after inspection.

This warranty is invalidated if any of the following occurs, but not limited to:

- Failure to follow instruction in the User's Manual.
- Accidental or unreasonable use, misuse or mishandling, over charging or loading, or normal wear.
- Extended storage without recharging or repairs done by an unauthorized person or modification.

This warranty is in lieu of all other express warranties. RoyPow will not be liable for consequential or incidental damages.

100
101
102
103
104
105
106
107
108
109
110
111
112
113
114
115
116
117
118
119
120
121
122
123
124
125
126
127
128
129
130
131
132
133
134
135
136
137
138
139
140
141
142
143
144
145
146
147
148
149
150
151
152
153
154
155
156
157
158
159
160
161
162
163
164
165
166
167
168
169
170
171
172
173
174
175
176
177
178
179
180
181
182
183
184
185
186
187
188
189
190
191
192
193
194
195
196
197
198
199
200
